

# TIPOS DE HIELO

## USOS Y APLICACIONES





# TIPOS DE HIELO

## HIELO GOURMET



Alfa Mini



Gala



Pulsar



Delta Max



Super Star



Super Star Plus

### CARACTERÍSTICAS

- Hielo puro, transparente, cristalino, sin huecos ni aristas.
- Perfecto para copas y combinados.
- Gira en la copa y enfría sin aguar.
- ITV fabrica este hielo en 6 tamaños.



## HIELO HUECO



Quasar

### CARACTERÍSTICAS

- Hielo de fácil manipulación, muy versátil.
- Máquina muy fiable.
- Capaz de producirse en las condiciones más adversas de calidad del agua y temperatura.
- Se funde rápido.



## HIELO DADO Y MEDIO DADO



Spika Dado



Spika Medio Dado

### CARACTERÍSTICAS

- Hielo perfecto para QSR y grandes consumos.
- Enfría rápidamente.
- Hielo dispensable automáticamente.
- Ideal para refrescos.
- ITV fabrica este hielo en dos formatos (Dado y medio dado).



## HIELO NUGGET



Nugget

### CARACTERÍSTICAS

- Hielo perfecto para combinados. Mezcla suavemente los sabores sin aguar la bebida.
- También se utiliza para enfriar zumos de frutas o yogures en exposiciones de alimentos.
- Humedad del 10%.
- Textura compacta, a medio camino entre el cubito y el hielo triturado, de troceado regular.
- Hielo crujiente que no resta sabor a la bebida.



## HIELO GRANULAR O TROCEADO



Diamond

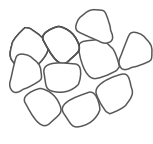

Chip



Granular

### CARACTERÍSTICAS

- Hielo perfecto para pescaderías, exposición de alimentos, sector sanitario e industria.
- Enfría rápidamente.
- Temperatura de 0°C a -1°C
- 1,6 M<sup>3</sup> equivale a 1 TM de hielo.
- ITV fabrica este hielo en tres formatos (Diamante, granular y chip)



## HIELO EN ESCAMAS



Scala

### CARACTERÍSTICAS

- Hielo perfecto para industria alimentaria, construcción y transporte.
- Escama plana muy fría y seca.
- Humedad del 2%.
- Temperatura -7°C.
- 2 M<sup>3</sup> equivalen a 1 TM de hielo.



# TIPOS DE HIELO

## CUBITOS



**TURBO SYSTEM**  
SISTEMA TURBO

### Pulsar

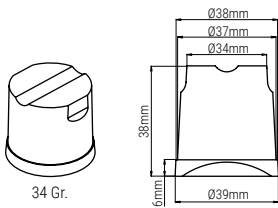

**PRODUCCIÓN KG/LB**

Desde 25/50 hasta 145/300



**PADDLE SYSTEM**  
SISTEMA DE PALETAS

### Quasar

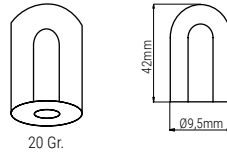

**PRODUCCIÓN KG/LB**

Desde 20/35 hasta 190/420



**VERTICAL SYSTEM**  
SISTEMA VERTICAL

### Spika FD/HD

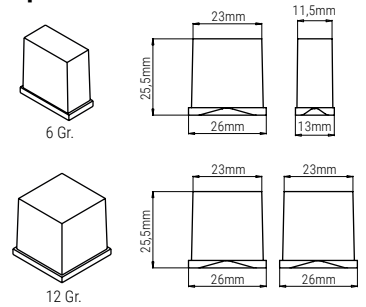

**PRODUCCIÓN KG/LB**

Desde 60/115 hasta 400/880



**SPRAY SYSTEM**  
SISTEMA DE DUCHAS

### Mini Alfa

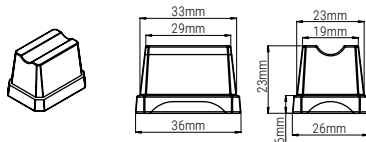

**PRODUCCIÓN KG/LB**

Desde 20/35 hasta 400/883

### Gala

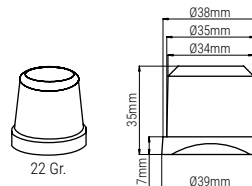

### Delta Max

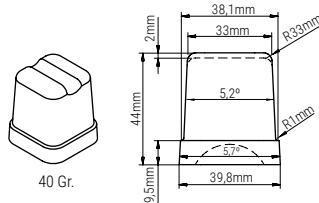

40 Gr.

### Super Star +

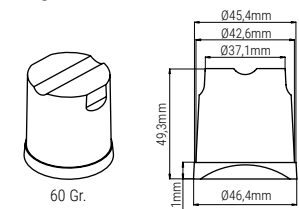

### Super Star

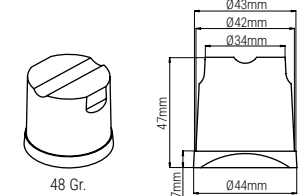

48 Gr.

## HIELO NUGGET

### Nugget



HIELO NUGGET

**PRODUCCIÓN KG/LB**

Desde 300/661 hasta 500/1102

## HIELO GRANULAR

### Ice Queen



HIELO DIAMOND



HIELO GRANULAR



HIELO CHIP

**PRODUCCIÓN KG/LB**

Desde 50/85 hasta 1100/2425

## HIELO EN ESCAMAS

### Scala



























HIELO EN ESCAMAS

**PRODUCCIÓN KG/LB**



































Desde 400/750 hasta 50T/110K

# USOS DEL HIELO

	TIPO DE HIELO	CANTIDAD	GAMA
Bar tradicional	 	0,1 Kg / cliente	Alfa / Quasar
Cafetería	 	0,04 Kg / cliente	Gala / Quasar
Pub, Club		0,25 Kg / cliente	Delta Max / Pulsar
Night Club		0,3 Kg / cliente	Delta Max / Super Star Plus
Discotecas		0,3 Kg / cliente	Super Star Plus
Bebidas Premium		2 piezas hielo / vaso	Gala / Delta / Pulsar
Combinados	 	3 piezas hielo / vaso	Super Star Plus / Nugget
Refrescos		3 piezas hielo / vaso	Alfa / Gala / Delta Max / Pulsar
Fast Food		0,07 Kg / Vaso SMALL	Spika
		0,11 Kg / Vaso MEDIUM	Spika
		0,15 Kg / Vaso LARGE	Spika
Restaurante Estándar	 	0,15 Kg / Cliente	Alfa / Gala / Delta Max / Pulsar / Quasar
Restaurante	 	0,3 Kg / Cliente	Alfa / Gala / Delta Max / Pulsar / Quasar
Restaurante Marisquería	 	0,5 Kg / Cliente	Alfa / Gala / Delta Max / Pulsar / Quasar
		1,25 Kg / Cliente	Ice Queen
Hotel		0,3 Kg / Habitación	Alfa / Gala / Delta Max / Pulsar
Camping		0,3 Kg / Plaza	Alfa / Gala / Quasar
		0,8 Kg / Plaza	Ice Queen
Residencia		0,2 Kg / Habitación	Alfa / Gala / Quasar

	CUBITO SÓLIDO
	DADO/MEDIO DADO
	CUBITO HUECO
	HIELO NUGGET
	HIELO GRANULAR
	HIELO ESCAMAS



	TIPO DE HIELO	CANTIDAD	GAMA
Exposición bebidas/alimentos	  	1 Kg / Cubitera simple	Ice Queen / Quasar / Nugget
	  	6 Kg / Cubo de hielo	Ice Queen / Quasar / Nugget
Bandeja marisco	 	1,3 Kg / Bandeja SMALL	Ice Queen / Scala
	 	3 Kg / Bandeja MEDIUM	Ice Queen / Scala
	 	6 Kg / Bandeja LARGE	Ice Queen / Scala
Bufet sobre hielo 10cm.		70 Kg / m <sup>2</sup>	Ice Queen
		12 Kg / Bandeja gastronorm 1/1	Ice Queen
Pescadería exposición		1m <sup>2</sup> 10 cm 100 Kg	Ice Queen
		1m <sup>2</sup> 10 cm 85 Kg	Scala
Pescadería Almacén / Cámara		0,30 Kg / 1 Kg pescado	Ice Queen
Hospital		0,30 Kg / Paciente	Alfa / Gala
Laboratorio		1 Kg / Cubeta	Ice Queen
		5 Kg / Nevera	Ice Queen
Fisioterapia		0,80 Kg / Paciente	Ice Queen
Rice-recuperación		0,5 Kg / Aplicación	Ice Queen
Spa's-Ducha hielo		150 Kg / Ducha	Ice Queen
Laser terapia		0,30 Kg / Paciente	Ice Queen
Industria pesquera	 	Cámara 0,30 Kg / 1 Kg pescado	Ice Queen / Scala
	 	Embarcado Z.tropical 1 Kg / 1 Kg pescado	Ice Queen / Scala
	 	Embarcado Z.tropical 1 Kg / 1 Kg pescado	Ice Queen / Scala
Industria cárnica	 	0,25 Kg / 1 Kg	Ice Queen / Scala
Industria panadera	 	0,20 Kg / 1 Kg	Ice Queen / Scala
Tinturas	 	0,50 Kg / 1 m <sup>2</sup>	Ice Queen / Scala
Hormigón		50 Kg / 1 m <sup>3</sup>	Scala

	CUBITO SÓLIDO
	DADO/MEDIO DADO
	CUBITO HUECO
	HIELO NUGGET
	HIELO GRANULAR
	HIELO ESCAMAS



# APLICACIONES

## HOSTELERÍA & QSR





# APLICACIONES

## INDUSTRIAL



# APLICACIONES

## RETAIL



## SALUD







C/00000\_05/AJ/21  
ITV ICE MAKERS, S.L.  
POL. IND. SECTOR 13, AVDA. DELS HOSTALERS, 2 46394  
RIBARROJA DE TURIA, VALENCIA, SPAIN  
PHONE: +34 96 166 75 75 | FAX: +34 96 166 81 00  
comercial@itv.es | www.itv.es